



DD AF-CA

English

DD AF-CA

Original operating instructions

1 Information about the documentation

1.1 About this documentation

- Read this documentation before initial operation or use. This is a prerequisite for safe, trouble-free handling and use of the product.
- Observe the safety instructions and warnings in this documentation and on the product.
- Always keep the operating instructions with the product and make sure that the operating instructions are with the product when it is given to other persons.

1.2 Explanation of symbols used

1.2.1 Warnings

Warnings alert persons to hazards that occur when handling or using the product. The following signal words are used:

DANGER

DANGER !

- ▶ Draws attention to imminent danger that will lead to serious personal injury or fatality.

WARNING

WARNING !

- ▶ Draws attention to a potential threat of danger that can lead to serious injury or fatality.





CAUTION

CAUTION !

- ▶ Draws attention to a potentially dangerous situation that could lead to slight personal injury or damage to the equipment or other property.





1.2.2 Symbols in the documentation

The following symbols are used in this document:

	Read the operating instructions before use.
	Instructions for use and other useful information
	Dealing with recyclable materials
	Do not dispose of electric equipment and batteries as household waste

1.2.3 Symbols in the illustrations

The following symbols are used in illustrations:

	These numbers refer to the corresponding illustrations found at the beginning of these operating instructions
	The numbering reflects the sequence of operations shown in the illustrations and may deviate from the steps described in the text
	Item reference numbers are used in the overview illustrations and refer to the numbers used in the product overview section
	This symbol is intended to draw special attention to certain points when handling the product.

1.3 Symbols on the product

1.3.1 Status indicator

The following symbols are used on the product:



Service indicator

1.3.2 Product-dependent symbols

The following symbols can be used on the product:

	Alternating current
n_0	Rated speed under no load
\varnothing	Diameter
/min	Revolutions per minute
	Wireless data transfer

1.4 Product information

HILTI products are designed for professional users and only trained, authorized personnel are permitted to operate, service and maintain the products. This personnel must be specifically informed about the possible hazards. The product and its ancillary equipment can present hazards if used incorrectly by untrained personnel or if used not in accordance with the intended use.

The type designation and serial number are printed on the rating plate.

- ▶ Write down the serial number in the table below. You will be required to state the product details when contacting Hilti Service or your local Hilti organization to inquire about the product.

Product information

Drilling feed unit	DD AF-CA
Generation:	01
Serial no.:	

1.5 Declaration of conformity

We declare, on our sole responsibility, that the product described here complies with the applicable directives and standards. A copy of the declaration issued by the certification department can be found at the end of this documentation.

The technical documentation is filed here:

Hilti Entwicklungsgesellschaft mbH | Tool Certification | Hiltistrasse 6 | 86916 Kaufering, Germany

2 Safety

2.1 General power tool safety warnings

⚠ WARNING Read all safety warnings, instructions, illustrations and specifications provided with this power tool. Failure to follow all instructions listed below may result in electric shock, fire and/or serious injury. **Save all warnings and instructions for future reference.**

The term "power tool" in the warnings refers to your mains-operated (corded) power tool or battery-operated (cordless) power tool.

Work area safety

- ▶ **Keep work area clean and well lit.** Cluttered or dark areas invite accidents.
- ▶ **Do not operate power tools in explosive atmospheres, such as in the presence of flammable liquids, gases or dust.** Power tools create sparks which may ignite the dust or fumes.
- ▶ **Keep children and bystanders away while operating a power tool.** Distractions can cause you to lose control.

Electrical safety

- ▶ **Power tool plugs must match the outlet. Never modify the plug in any way. Do not use any adapter plugs with earthed (grounded) power tools.** Unmodified plugs and matching outlets will reduce risk of electric shock.

- ▶ **Avoid body contact with earthed or grounded surfaces, such as pipes, radiators, ranges and refrigerators.** There is an increased risk of electric shock if your body is earthed or grounded.
- ▶ **Do not expose power tools to rain or wet conditions.** Water entering a power tool will increase the risk of electric shock.
- ▶ **Do not abuse the cord. Never use the cord for carrying, pulling or unplugging the power tool. Keep cord away from heat, oil, sharp edges or moving parts.** Damaged or entangled cords increase the risk of electric shock.
- ▶ **When operating a power tool outdoors, use an extension cord suitable for outdoor use.** Use of a cord suitable for outdoor use reduces the risk of electric shock.
- ▶ **If operating a power tool in a damp location is unavoidable, use a residual current device (RCD) protected supply.** Use of an RCD reduces the risk of electric shock.

Personal safety

- ▶ **Stay alert, watch what you are doing and use common sense when operating a power tool. Do not use a power tool while you are tired or under the influence of drugs, alcohol or medication.** A moment of inattention while operating power tools may result in serious personal injury.
- ▶ **Use personal protective equipment. Always wear eye protection.** Protective equipment such as a dust mask, non-skid safety shoes, hard hat or hearing protection used for appropriate conditions will reduce personal injuries.
- ▶ **Prevent unintentional starting. Ensure the switch is in the off-position before connecting to power source and/or battery pack, picking up or carrying the tool.** Carrying power tools with your finger on the switch or energising power tools that have the switch on invites accidents.
- ▶ **Remove any adjusting key or wrench before turning the power tool on.** A wrench or a key left attached to a rotating part of the power tool may result in personal injury.
- ▶ **Do not overreach. Keep proper footing and balance at all times.** This enables better control of the power tool in unexpected situations.
- ▶ **Dress properly. Do not wear loose clothing or jewellery. Keep your hair, clothing and gloves away from moving parts.** Loose clothes, jewellery or long hair can be caught in moving parts.
- ▶ **If devices are provided for the connection of dust extraction and collection facilities, ensure these are connected and properly used.** Use of dust collection can reduce dust-related hazards.
- ▶ **Do not let familiarity gained from frequent use of tools allow you to become complacent and ignore tool safety principles.** A careless action can cause severe injury within a fraction of a second.

Power tool use and care

- ▶ **Do not force the power tool. Use the correct power tool for your application.** The correct power tool will do the job better and safer at the rate for which it was designed.
- ▶ **Do not use the power tool if the switch does not turn it on and off.** Any power tool that cannot be controlled with the switch is dangerous and must be repaired.
- ▶ **Disconnect the plug from the power source and/or remove the battery pack, if detachable, from the power tool before making any adjustments, changing accessories, or storing power tools.** Such preventive safety measures reduce the risk of starting the power tool accidentally.
- ▶ **Store idle power tools out of the reach of children and do not allow persons unfamiliar with the power tool or these instructions to operate the power tool.** Power tools are dangerous in the hands of untrained users.
- ▶ **Maintain power tools and accessories. Check for misalignment or binding of moving parts, breakage of parts and any other condition that may affect the power tool's operation. If damaged, have the power tool repaired before use.** Many accidents are caused by poorly maintained power tools.
- ▶ **Keep cutting tools sharp and clean.** Properly maintained cutting tools with sharp cutting edges are less likely to bind and are easier to control.
- ▶ **Use the power tool, accessories and tool bits etc. in accordance with these instructions, taking into account the working conditions and the work to be performed.** Use of the power tool for operations different from those intended could result in a hazardous situation.
- ▶ **Keep handles and grasping surfaces dry, clean and free from oil and grease.** Slippery handles and grasping surfaces do not allow for safe handling and control of the tool in unexpected situations.

2.2 Diamond drill safety warnings

- ▶ **When performing drilling that requires the use of water, route the water away from the operator's work area or use a liquid collection device.** Such precautionary measures keep the operator's work area dry and reduce the risk of electrical shock.

- ▶ **Operate power tool by insulated grasping surfaces, when performing an operation where the cutting accessory may contact hidden wiring or its own cord.** Cutting accessory contacting a “live” wire may make exposed metal parts of the power tool “live” and could give the operator an electric shock.
- ▶ **Wear hearing protection when diamond drilling.** Exposure to noise can cause hearing loss.
- ▶ **When the bit is jammed, stop applying downward pressure and turn off the tool.** Investigate and take corrective actions to eliminate the cause of the bit jamming.
- ▶ **When restarting a diamond drill in the workpiece check that the bit rotates freely before starting.** If the bit is jammed, it may not start, may overload the tool, or may cause the diamond drill to release from the workpiece.
- ▶ **When securing the drill stand with anchors and fasteners to the workpiece, ensure that the anchoring used is capable of holding and restraining the machine during use.** If the workpiece is weak or porous, the anchor may pull out causing the drill stand to release from the workpiece.
- ▶ **When drilling through walls or ceilings, ensure to protect persons and the work area on the other side.** The bit may extend through the hole or the core may fall out on the other side.
- ▶ **Do not use this tool for overhead drilling with water supply.** Water entering the power tool will increase the risk of electric shock.

2.3 Additional safety instructions

Personal safety

- ▶ **Do not tamper with or attempt to make alterations to the machine.**
- ▶ **The machine is not intended for use by debilitated persons who have received no special training.**
- ▶ Keep the machine out of reach of children.
- ▶ **Do not touch rotating parts. Switch the machine on only after it is in position at the workpiece.** Touching rotating parts, especially rotating accessory tools, can result in injury.
- ▶ **Avoid skin contact with drilling slurry.**
- ▶ Dust from materials such as lead-based paint, certain types of wood and concrete/masonry/stone containing quartz, minerals or metal can be harmful to health. Contact with or inhalation of the dust can cause allergic reactions and/or respiratory or other diseases among operators or bystanders. Certain kinds of dust such as oakwood and beechwood dust are classified as carcinogenic, especially in conjunction with additives for wood conditioning (chromate, wood preservative). Only specialists are permitted to handle material containing asbestos. Use as effective a dust removal system as possible. To achieve a high level of dust collection, use a suitable vacuum extractor of the type recommended by Hilti for wood dust and/or mineral dust and which is designed for use with this power tool. Make sure that the workplace is well ventilated. It is advisable to wear a respirator appropriate for the type of dust generated. Comply with national regulations applicable to the materials you will be working with.
- ▶ The diamond core drilling machine and the diamond core bit are heavy. There is a risk of crushing parts of the body. **The user and persons in the vicinity must wear suitable protective goggles, a hard hat, ear defenders, protective gloves and protective footwear while the machine is in use.**

Power tool use and care

- ▶ **Make sure that the machine is correctly secured to the drill stand.**
- ▶ **Always make sure that an end stop is installed on the drill stand as otherwise the safety-relevant end-stop function is not implemented.**
- ▶ **Check that accessory tools are compatible with the machine’s chuck/drive system and that they are installed and secured correctly.**

Electrical safety

- ▶ **Do not use extension cords with multiple power outlets powering two or more devices in operation at the same time.**
- ▶ **Operate the machine only when it is connected to an adequately rated power supply with a ground conductor.**
- ▶ **Before beginning work, check the working area (e.g. using a metal detector) to ensure that no concealed electric cables or gas and water pipes are present.** External metal parts of the machine can become live, for example if you inadvertently damage electric wiring. This constitutes a serious risk of electric shock.
- ▶ **Make sure that the supply cord cannot be damaged as the carriage advances.**
- ▶ **Never operate the machine without the accompanying PRCD (machines without PRCD: Never operate the machine without an isolating transformer). Test the PRCD each time before use.**
- ▶ **Check the machine’s supply cord at regular intervals and have it replaced by a qualified specialist if found to be damaged. If the machine’s supply cord is damaged it must be replaced with a specially**

prepared and approved supply cord available from Hilti Customer Service. Check extension cords at regular intervals and replace them if found to be damaged. Do not touch the supply cord or extension cord if it is damaged while working. Disconnect the supply cord plug from the power outlet. Damaged supply cords or extension cords present a risk of electric shock.

- ▶ **Never operate the machine when it is dirty or wet.** Dust (especially dust from conductive materials) or dampness adhering to the surface of the machine may, under unfavorable conditions, lead to electric shock. Dirty or dusty machines should thus be checked by Hilti Service at regular intervals, especially if used frequently for working on conductive materials.

Workplace

- ▶ **Approval must be obtained from the site engineer or architect prior to beginning drilling work.** Drilling work on buildings and other structures may influence the static equilibrium of the structure, especially when steel reinforcing bars or load-bearing components are cut through.
- ▶ **If the drill stand has not been fastened correctly, always move the machine mounted on the drill stand all the way down in order to prevent the stand from falling over.**
- ▶ **Keep the supply cord, extension cord, water hose and vacuum hose away from rotating parts of the machine.**
- ▶ **Use of the water collection system in conjunction with a wet-type industrial vacuum extractor is a mandatory requirement for wet drilling overhead.**
- ▶ **Use of the vacuum securing method without an additional means of fastening is prohibited for drilling in an upward direction.**
- ▶ **An additional means of securing the drill stand must be employed when the machine is secured with the vacuum securing method (accessory) for horizontal drilling.**

3 Description

3.1 Parts and operating controls

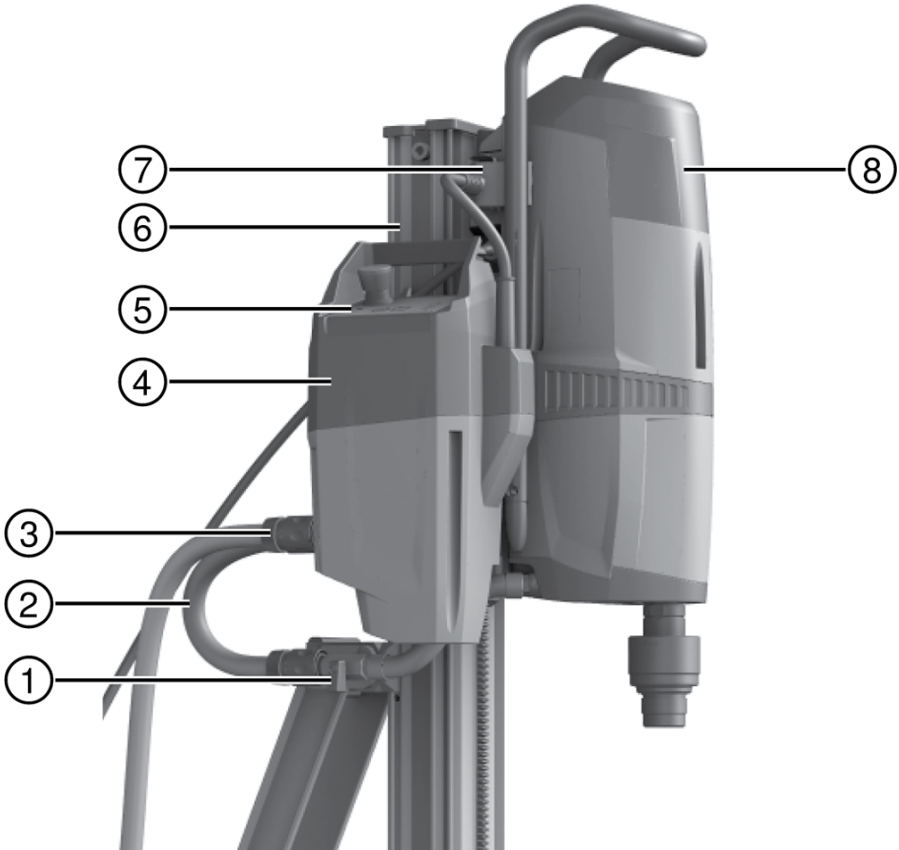

- | | | | |
|---|---|---|--|
| ① | Water flow regulator on the diamond core drilling machine | ⑤ | Control panel and display |
| ② | Hose connection to the diamond core drilling machine | ⑥ | Drill stand |
| ③ | Water supply connection | ⑦ | Connector for electric power and communication |
| ④ | Drilling feed unit | ⑧ | Diamond core drilling machine |

3.2 Control panel and display

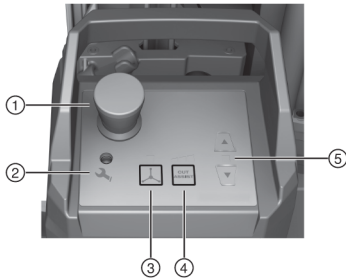

- ① **Emergency stop** button
- ② Service indicator
- ③ Button and LED: **Manual mode**
- ④ Button and LED: **CUT ASSIST** Mode
- ⑤ Positioning buttons with LED

3.3 Intended use

The DD AF-CA drilling feed unit, a diamond core drilling machine and a drill stand recommended by **Hilti** together form an automatic diamond core drilling system suitable for wet core drilling in mineral materials.

- When in operation, the DD AF-CA must always be mounted on the drill stand.
- The drill stand must always be secured using the anchor spindle and a suitable anchor.
- When in operation, the DD AF-CA must be connected to a cooling water supply that meets the minimum specifications given in the technical data.

Comply with the safety rules and operating instructions for the accessories used.

The product, accessories and tools can present hazards if used incorrectly by untrained personnel or if used not in accordance with the intended use.

Always comply with these operating instructions and also with the operating instructions for the other components of the diamond core drilling system.

3.4 Items supplied

DD AF-CA drilling feed unit, securing screw, operating instructions

Other system products approved for use with this product can be found at your local **Hilti Store** or at: www.hilti.group.

3.5 Control panel and display

Emergency stop button	Emergency stop	Press the Emergency stop button to stop drilling instantly. The diamond core drilling system is still under electric power, but operation can be resumed only after the emergency stop button has been released.
	Releasing the emergency stop button	To cancel the emergency stop, turn the Emergency stop button and pull it out, then press the on/off switch of the diamond core drilling machine.
Service indicator	LED flashes red	A malfunction that can be remedied, e.g. overheating. See the section headed " Troubleshooting ".

Service indicator	The LED lights up red	Disconnect the system from the electricity supply and then reconnect. See the section headed " Troubleshooting ".
<p>Mode indicator (1) Manual mode button(2)</p>	LED lights up continuously	Manual control by hand wheel activated.
	LED does not light up	Automatic control with CUT ASSIST activated.
<p>Power indicator (3) CUT ASSIST button (4) / Power setting</p>	Pressing the button activates manual mode. In manual mode the water is free to flow. Water from the water supply flows out through the core bit. Pressing the button deactivates manual mode.	
	3 LEDs light up	Full power (preselected after switching on).
	2 LEDs light up	Medium power (approx. 85%).
	1 LED lights up	Low power (approx. 65%).
<p>Carriage positioning buttons(5) Carriage positioning indicator(6)</p>	When you switch back from manual mode, CUT ASSIST is activated at full power. CUT ASSIST does not start the flow of cooling water until drilling commences and it stops the flow of water when drilling ends. Repeatedly pressing the button cycles through the power levels one after the other. Pressing the deactivates CUT ASSIST.	
	LED lights up continuously	CUT ASSIST active; the arrow buttons can be used to position the carriage.
	LED does not light up	CUT ASSIST deactivated; the hand wheel has to be used for positioning the carriage, or automatic drilling in progress.
	LED flashes	Automatic break-through detection has been manually deactivated. The diamond core drilling machine does not stop drilling automatically when the core bit breaks through to the other side of the object being drilled.

4 Technical data

4.1 Product properties

Weight, ready for use	9.9 lb (4.5 kg)
Dimensions (L×W×H)	14.2 in x 7.6 in x 5.2 in (361 mm x 193 mm x 133 mm)
Output voltage (DC)	5 V
Output current	50 mA
Speed of rotation	0 /min ... 75 /min
Max. permissible water supply pressure	≤ 90 psi (≤ 6 bar)
Minimum water flow rate	≥ 0.1 liq. gal _{US} /min (≥ 0.5 ℓ/min)
max. cooling-water temperature	≤ 86 °F (≤ 30 °C)
Protection class	Protection class I (earthed)
Protection class (dust, water)	IP 55

4.2 Rated voltage

Rated voltage	110 V	220 V ... 240 V	380 V ... 415 V
Rated frequency	50 Hz ... 60 Hz	50 Hz ... 60 Hz	50 Hz ... 60 Hz
Rated current input	0.6 A	0.4 A	0.25 A

5 Preparations at the workplace and starting work

5.1 Installing the drilling feed unit

CAUTION

Risk of injury Hazard presented by inadvertent starting of the diamond core drilling machine.

- ▶ The diamond core drilling machine should not be connected to the power supply during set-up.

WARNING

Risk of injury! The drill stand can rotate or topple if not securely fastened.

- ▶ Before using the diamond core drilling machine, secure the drill stand to the work surface with anchors or with a vacuum base plate.
- ▶ Use only anchors suitable for the base material and comply with the anchor manufacturer's instructions.
- ▶ Use a vacuum base plate only when the work surface is suitable for securing the drill stand by the vacuum method.

The supply voltage must match the ratings stated on the type identification plate of the diamond core drilling machine. Connect a 110 V drilling feed unit only to a 110 V diamond core drilling machine.

Connect the drilling feed unit only to a diamond core drilling machine recommended by **Hilti**.

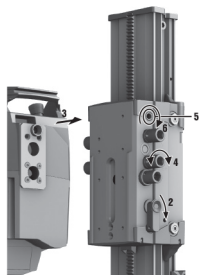

1. Check that the carriage is suitable for installation of a drilling feed unit.
2. Lock the carriage with the carriage lock.
3. Position the drilling feed unit on the carriage.



Make sure that the drilling feed unit is in uniform, all-round contact with the carriage. If necessary, adjust the position of the carriage until the drilling feed unit is in correct, uniform contact.

4. Insert the fastening screw through the carriage and into the drilling feed unit.
5. Tighten the securing screw by hand.
6. Remove the hand wheel.
7. Connect the water hose to the diamond core drilling machine.
8. Connect the water supply to the drilling feed unit.
9. Check the mechanical connection between the drilling feed unit and the carriage.

5.2 Making the electrical connection

1. Remove the protective caps from the socket and the connecting cable.



Fit the protective caps into each other in order to keep them clean.

2. Plug the connecting cable into the socket.

5.3 Ensuring supply of cooling water



The drilling feed unit and the diamond core drilling machine are water-cooled tools.

Make sure that the water inlet of the drilling feed unit's cooling circuit is correctly connected to a water hose at all times during operation. This also applies when dry drilling operations are carried out.

Make sure that the minimum water flow rate and the water temperature meet the requirements stated in the technical data.

6 Operation

6.1 Performing the core drilling operation



DANGER

Risk of injury due to failure to observe the danger zone! The drilling feed unit is always in Cut Assist mode immediately after being switched on and it starts the drilling process automatically as soon as the switch on the diamond core drilling machine is pressed. The core bit is automatically advanced until it contacts the surface of the object to be drilled.

- ▶ Make sure there is no-one in the danger zone!
- ▶ Keep the zone between the core bit and the surface of the object to be drilled clear!



IMPORTANT! The emergency stop function does not work if the drilling feed unit is not connected to the diamond core drilling machine!

IMPORTANT! Switching other power tools, machines or appliances on and off can cause undervoltage dips and/or overvoltage peaks, resulting in damage to the product. Never operate other power tools or appliances off the generator or transformer at the same time!

6.2 Working principle, CUT ASSIST

In CUT ASSIST mode, the drilling operation starts after you press the **I** button on the diamond core drilling machine. The drilling operation consists of 3 phases:

1. The core bit is advanced at a standstill until it comes into contact with the surface of the object to be drilled. The system detects contact with the surface and retracts the core bit slightly so that it is clear of the surface.
2. The cooling water starts to flow and the core bit starts rotating at low hole-starting speed.
3. The core bit advances into contact with the surface and the system drills at hole-starting speed until the appropriate hole-starting depth is reached.

When the appropriate hole-starting depth is reached the system continues drilling, automatically adjusting to optimum speed and optimum power.

If the core bit hits reinforcement, the **Iron Boost** function is activated automatically. Power is adapted for cutting through the reinforcement. Weak reinforcement might not be detected under certain circumstances, in which case the **Iron Boost** function is not activated.

6.2.1 Hole starting with small diameters

For core bits of diameter < 202 mm (< 8 in), it is advisable to start the hole with very low pressure and the preset drilling speed.

→ After the core bit starts to rotate (phase 2), press the **I** button on the diamond core drilling machine.

6.2.2 Hole-starting in existing guides in the object to be drilled

If the core bit has a guide to follow in the object to be drilled, it is advisable to skip the hole-starting stage and proceed right away to drilling with optimum power and speed.

→ After the core bit starts to rotate (phase 2), press the **I** button on the diamond core drilling machine.

6.2.3 Depth gage

When drilling a blind hole (not all the way through), the drilling feed unit stops the advance movement as soon as the carriage contacts the depth gauge.

6.2.4 Automatic break-through detection

When through holes are drilled without use of a depth gauge, the core bit feed movement continues until the core bit projects approx. 3 cm out of the exit hole.

At the end of the drilling operation, the core bit is automatically retracted until only the tip of the core bit remains in the drillhole. The water supply is then shut off automatically.

6.2.5 Deactivating automatic break-through detection

You can deactivate automatic break-through detection, for example when you are going to drill very deep holes or drill into heterogeneous materials with possible cavities.



The **Iron Boost** function remains active even when automatic break-through detection has been deactivated.



WARNING

Risk of injury! Injury can result if someone is in the danger zone when the core bit breaks through. With automatic break-through detection deactivated, after the hole has been drilled right through the material the core bit continues to rotate and does not stop automatically.

- ▶ Make sure there is no-one in the danger zone.
- ▶ Fit the depth gauge.

1. Press the button.
2. Simultaneously press the buttons and .
- ↳ The **Carriage positioning** LED indicator flashes.
- ↳ Automatic break-through detection is deactivated.



To reactivate automatic break-through detection, repeat steps 1 to 2 or switch the system off and then on again.

6.3 Drilling with CUT ASSIST



WARNING

Risk of injury! The rotating hand wheel can cause injuries.

- ▶ Remove the hand wheel from the carriage before starting to drill with CUT ASSIST.



When CUT ASSIST is active and you press the button on the diamond core drilling machine, automatic power adaptation when reinforcement is contacted is switched off. As a result, until the end of the drilling operation, you will then have to regulate drilling power manually when drilling through reinforcing bars.

1. Activate the water flow by pressing the button.
 - ↳ Water issues at the core bit.
2. Activate the CUT ASSIST mode by pressing the button.
3. Use the button to adjust power, if necessary.
4. Start drilling as described in the section headed "Working principle, CUT ASSIST". → page 10

6.4 Drilling in manual mode

1. Press the button.
 - ↳ Water flow is activated and cooling water issues at the core bit.
2. Carry out by the drilling operation as described in the operating instructions for the diamond core drilling machine.

6.5 Breaks between work and storage at low temperatures

At temperatures below 4 °C (39 °F), the water in the cooling circuit has to be blown out with compressed air when drilling is interrupted for more than one hour and before the equipment is stowed away.

i In order for the water circuit to be drained, the diamond core drilling machine has to be connected to the electricity supply and to the drilling feed unit.

1. Disconnect the water supply from the drilling feed unit.
2. Open the water flow regulator on the diamond core drilling machine.
3. Set the 3-way valve to **Wet drilling**.
4. Press the  button.
5. Use compressed air (max. 3 bar) to blow the water out of the water circuit.

6.6 Removing the drilling feed unit

i The drilling feed unit can be removed independently of the diamond core drilling machine.

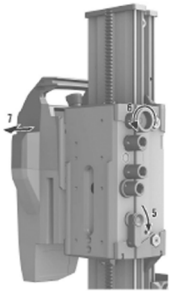

1. Unplug the connecting cable for the drilling feed unit from the socket of the diamond core drilling machine.
2. Fit the protective caps to the connecting cable and the socket.
3. Disconnect the water hose running to the diamond core drilling machine.
4. Lock the carriage with the carriage lock.
5. Secure the drilling feed unit so that it cannot accidentally drop; slacken the securing screw.
6. Remove the drilling feed unit.

7 Care, transport and storage

7.1 Care and maintenance



WARNING

Electric shock hazard! Attempting care and maintenance with the supply cord connected to a power outlet can lead to severe injury and burns.

- ▶ Always unplug the supply cord before carrying out care and maintenance tasks.

Care

- Carefully remove any dirt that may be adhering to parts.
- Clean the air vents carefully with a dry brush.
- Use only a slightly damp cloth to clean the casing. Do not use cleaning agents containing silicone as these may attack the plastic parts.

Maintenance

WARNING

Danger of electric shock! Improper repairs to electrical components may lead to serious injuries including burns.

- ▶ Repairs to the electrical section of the tool or appliance may be carried out only by trained electrical specialists.
-
- Check all visible parts and controls for signs of damage at regular intervals and make sure that they all function correctly.
 - Do not operate the product if signs of damage are found or if parts malfunction. Have it repaired immediately by **Hilti** Service.
 - After cleaning and maintenance, fit all guards or protective devices and check that they function correctly.



To help ensure safe and reliable operation, use only genuine Hilti spare parts and consumables. Spare parts, consumables and accessories approved by Hilti for use with the product can be found at your local **Hilti Store** or online at: www.hilti.group.

7.2 Transport and storage

Transport

- ▶ Do not transport this product with an accessory tool installed.
- ▶ Make sure that the equipment is held securely throughout all transport operations.
- ▶ After transporting, always check all visible parts and controls for signs of damage and make sure that they all function correctly.

Storage

- ▶ Always store this product with the electric supply cable unplugged from the electricity supply.
- ▶ Store this product in a dry place, where it cannot be accessed by children or unauthorized persons.
- ▶ After a long period of storage, always check all visible parts and controls for signs of damage and make sure that they all function correctly.

8 Troubleshooting

If the trouble you are experiencing is not listed in this table or you are unable to remedy the problem by yourself, please contact **Hilti** Service.

8.1 DD-AF CA is not in working order

Malfunction	Possible cause	Action to be taken
<p>The service indicator blinks.</p>	The emergency stop button has been pressed.	▶ Release the emergency stop button and press the off-switch on the diamond core drilling machine.
	Overheating.	▶ Allow the machine to cool down.
	Communication error.	▶ Check the connecting cable. Unplug the diamond core drilling machine's supply cord from the power outlet and then plug it back in again. Switch the diamond core drilling machine off and then on again.
<p>The service indicator lights.</p>	Critical error or fault.	<ul style="list-style-type: none"> ▶ Unplug the diamond core drilling machine's supply cord from the power outlet and then plug it back in again. ▶ Contact Hilti Service if the service indicator LED continues to light.

8.2 DD-AF CA is in working order

Trouble or fault	Possible cause	Action to be taken
The LEDs on the drilling feed unit don't light when the PRCD for the diamond core drilling machine is switched on.	The plug connector is faulty or dirty.	<ul style="list-style-type: none"> ▶ Unplug the diamond core drilling machine's supply cord from the power outlet. ▶ Check the plug connector between the drilling feed unit and the diamond core drilling machine.
The cable cannot be connected to the diamond core drilling machine.	The plug connector is dirty.	<ul style="list-style-type: none"> ▶ Unplug the diamond core drilling machine's supply cord from the power outlet. ▶ Clean the plug connector. ▶ Try again to plug in the connector without using force.
The drilling feed unit can't be fitted.	The threaded bushing for the securing screw is blocked.	<ul style="list-style-type: none"> ▶ Clean the threaded bushing.
The hand wheel cannot be rotated.	The carriage lock is engaged.	<ul style="list-style-type: none"> ▶ Release the carriage locking mechanism.
	The carriage is obstructed.	<ul style="list-style-type: none"> ▶ Make sure that the carriage is free to move.
The water flow rate is too low.	The diamond core drilling machine's water valve is blocked or defective.	<ul style="list-style-type: none"> ▶ Check that the water supply is installed correctly. ▶ Check the valve – it may be blocked or defective.
The drilling feed unit motor runs but the carriage doesn't move.	The drilling feed unit is fitted incorrectly.	<ul style="list-style-type: none"> ▶ Check the mechanical connection between the drilling feed unit and the carriage.
Cut Assist mode cannot be activated.	The plug connector for the diamond core drilling machine is faulty.	<ul style="list-style-type: none"> ▶ Check the plug connector.
	The emergency stop button has been pressed.	<ul style="list-style-type: none"> ▶ Release the emergency stop button and press the off-switch on the diamond core drilling machine.
The drilling operation slows or stops.	The diamond core bit is defective (segments polished or destroyed).	<ul style="list-style-type: none"> ▶ Sharpen the diamond core bit or replace it.
	The plug connector is faulty or the cable is defective.	<ul style="list-style-type: none"> ▶ Check the connection between the drilling feed unit and the diamond core drilling machine.
	The diamond core bit is stuck.	<ul style="list-style-type: none"> ▶ Disconnect the diamond core drilling machine from the electric supply. ▶ Release the diamond core bit.
	Faulty or inadequate cooling.	<ul style="list-style-type: none"> ▶ Check the water supply and cooling circuit.
	Stopped before reaching the target depth due to transition into softer material such as hollow brick, soil or natural stone.	<ul style="list-style-type: none"> ▶ Restart the drilling operation.

9 Disposal

Most of the materials from which **Hilti** tools and appliances are manufactured can be recycled. The materials must be correctly separated before they can be recycled. In many countries, your old tools, machines or appliances can be returned to **Hilti** for recycling. Ask **Hilti** Service or your Hilti representative for further information.



-
- ▶ Do not dispose of power tools, electronic equipment or batteries as household waste!
-

10 **Manufacturer's warranty**

- ▶ Please contact your local **Hilti** representative if you have questions about the warranty conditions.

This Product is Certified
Ce produit est homologué
Producto homologado por
Este producto está registrado





Hilti Corporation
LI-9494 Schaan
Tel.:+423 234 21 11
Fax:+423 234 29 65
www.hilti.group



2164701



Hilti Connect